

AT-SP3X

パワードブックシェルフスピーカー
Powered Bookshelf Speakers

クイックスタートガイド
Quick Start Guide

User Manual (Online Manual)

<https://www.audio-technica.co.jp/document/AT-SP3X/Default.html>



サポート

本製品の詳しい使いかたの確認や困ったときの解決方法については、当社ホームページ掲載の取扱説明書をご確認ください。

Support

For more information on how to use this product and troubleshoot any problems, refer to the user manual on the Audio-Technica website.

同梱品の確認 / Package contents

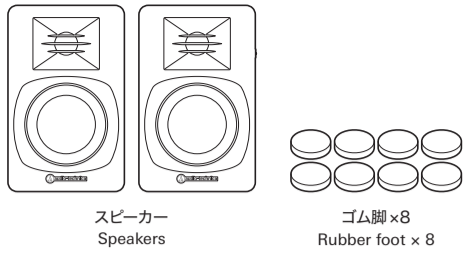

スピーカー
Speakers

ゴム脚×8
Rubber foot x 8

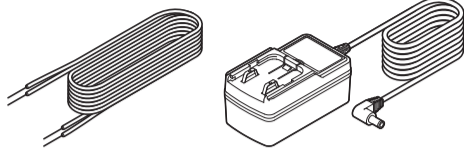

スピーカーケーブル
Speaker cable

ACアダプター
AC adapter

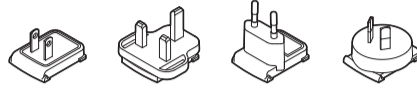

ACアダプター交換用プラグ×4
AC adapter replacement plug x 4

ゴム脚を貼り付ける / Attaching rubber feet

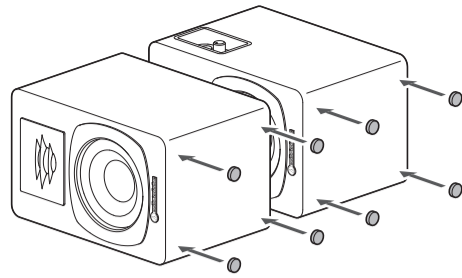

スピーカーケーブルを接続する /
Connecting the speaker cables

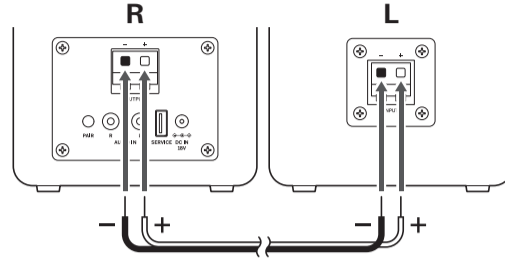

ACアダプターを接続する /
Connecting the AC adapter

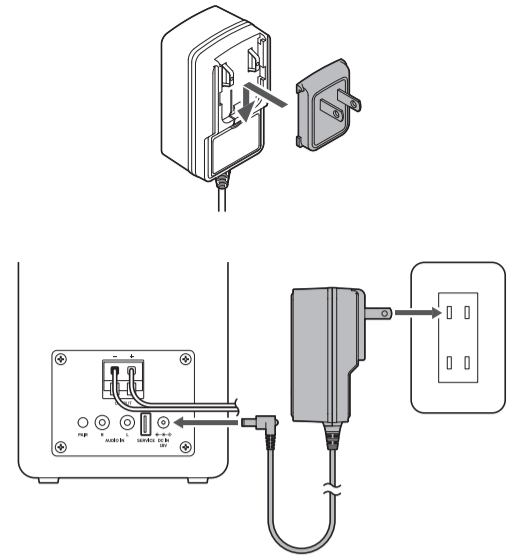

コンセントの差し込み口に合ったACアダプター交換用プラグを取り付けてください。
Install the AC adapter replacement plug that matches the outlet.

電源ON/OFF / Power ON/OFF

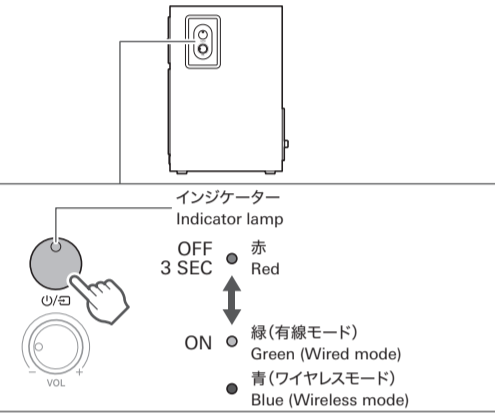

音量を調整する / Adjusting the volume

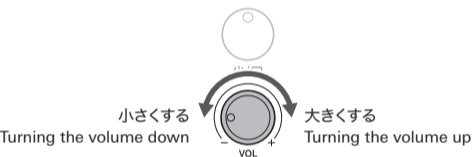

有線接続 / Wired connection

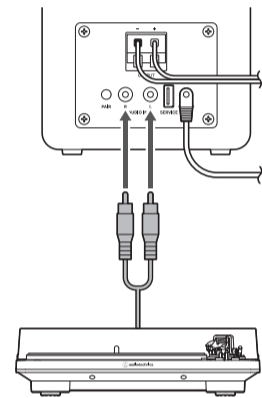

ワイヤレス接続 / Wireless connection

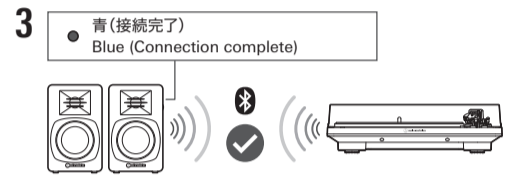
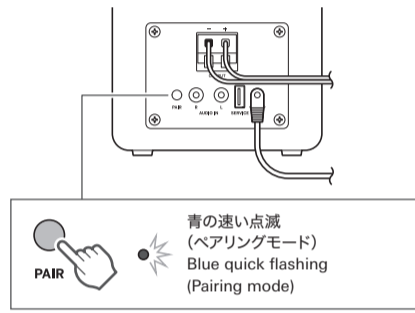
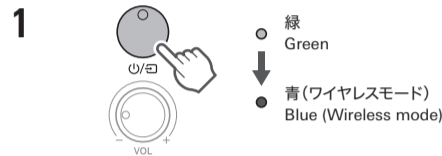

The Bluetooth® word mark and logos are registered trademarks owned by Bluetooth SIG, Inc., and any use of such marks by Audio-Technica Corporation is under license. Other trademarks and trade names are those of their respective owners.

株式会社オーディオテクニカ
〒194-8666 東京都町田市西成瀬2-46-1
www.audio-technica.co.jp

Audio-Technica Corporation
2-46-1 Nishi-naruse, Machida, Tokyo 194-8666, Japan
Global Support Contact: www.at-globalssupport.com
©2024 Audio-Technica Corporation

351710290-01-01

ver.1 2024.04.01

Français / Deutsch

User Manual (Online Manual)

<https://www.audio-technica.co.jp/document/AT-SP3X/Default.html>



Support

Pour plus d'informations sur l'utilisation de ce produit et la résolution des problèmes, reportez-vous au manuel de l'utilisateur sur le site Web d'Audio-Technica.

Unterstützung

Weitere Informationen zum Gebrauch dieses Produkts und zur Behebung eventueller Probleme entnehmen Sie bitte der Bedienungsanleitung auf der Website von Audio-Technica.

Contenu du paquet / Inhalt der Verpackung

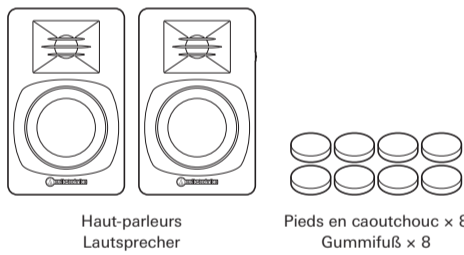

Haut-parleurs
Lautsprecher

Pieds en caoutchouc x 8
Gummifuß x 8

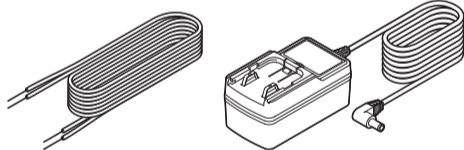

Câble des haut-parleurs
Lautsprecherkabel

Adaptateur secteur
Netzteil

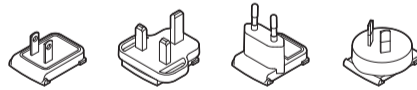

Prise de remplacement de l'adaptateur secteur x 4
Netzteil-Steckeraufsatz x 4

Installation des pieds en caoutchouc /
Anbringen der GummifüÙe

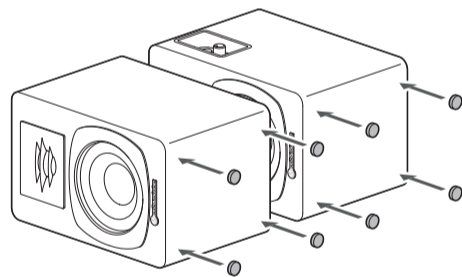

Branchement des câbles des haut-parleurs /
Anschließen der Lautsprecherkabel

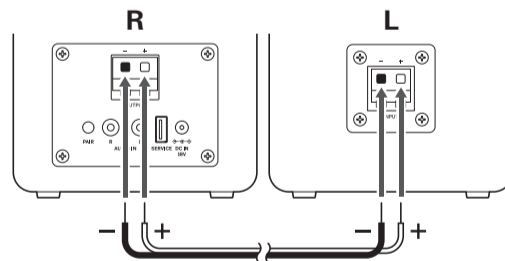

Branchement de l'adaptateur secteur /
Anschließen des Netzteils

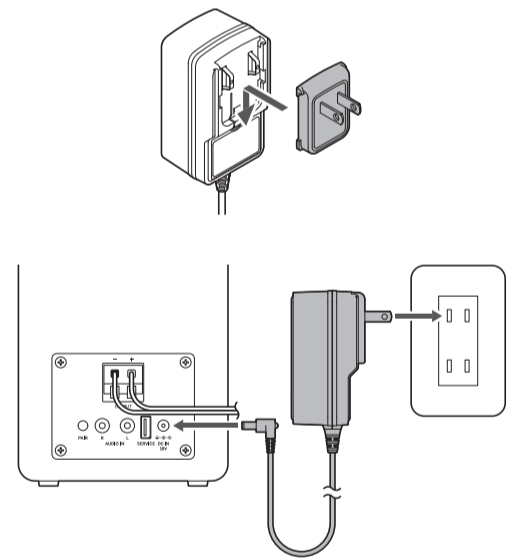

Installez la prise de remplacement de l'adaptateur secteur qui correspond à la prise.
Bringen Sie den Netzteil-Steckeraufsatz an, der in die Steckdose passt.

Mise sous tension/hors tension /
Stromversorgung EIN/AUS

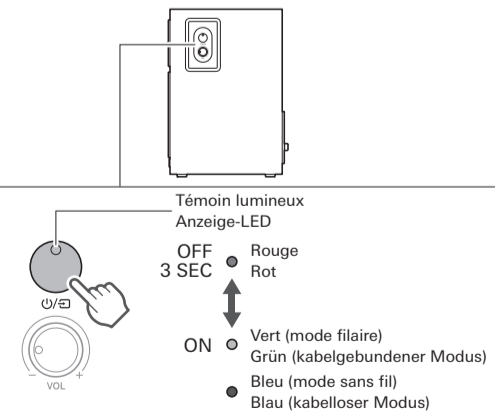

Réglage du volume / Einstellen der Lautstärke

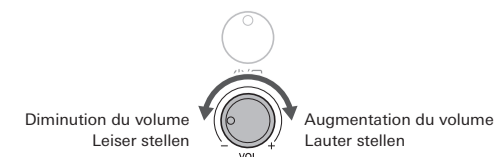

Connexion filaire / Kabelgebundene Verbindung

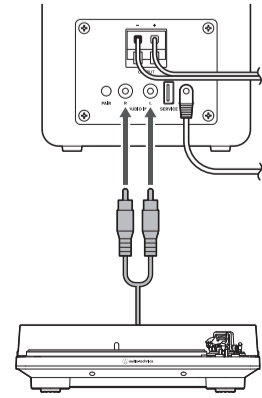
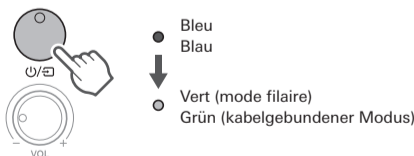

Connexion sans fil / Kabellose Verbindung

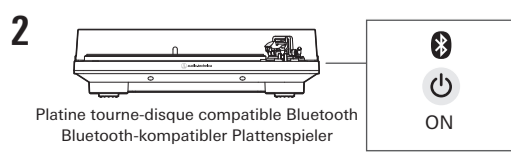
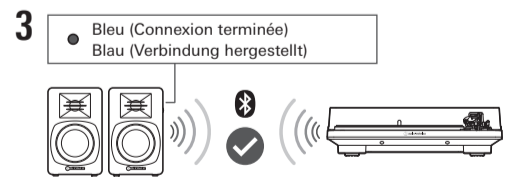
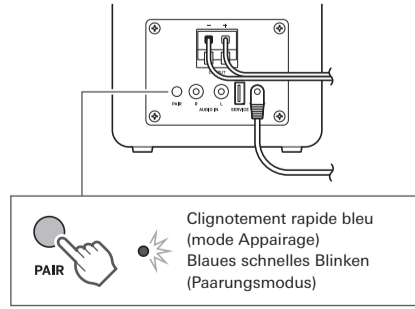
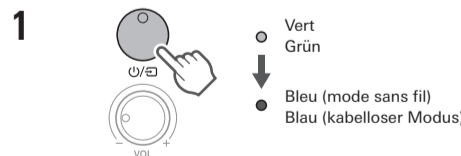

Contenuto della confezione / Contenido del embalaje

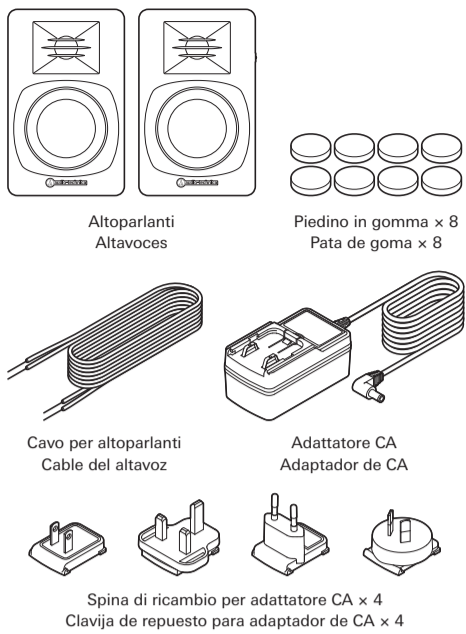

Fissaggio dei piedini in gomma / Colocación de las patas de goma

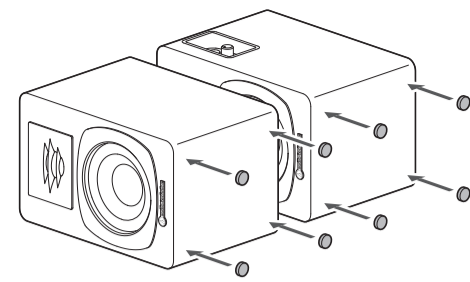

Collegamento dell'adattatore CA / Conexión del adaptador de CA

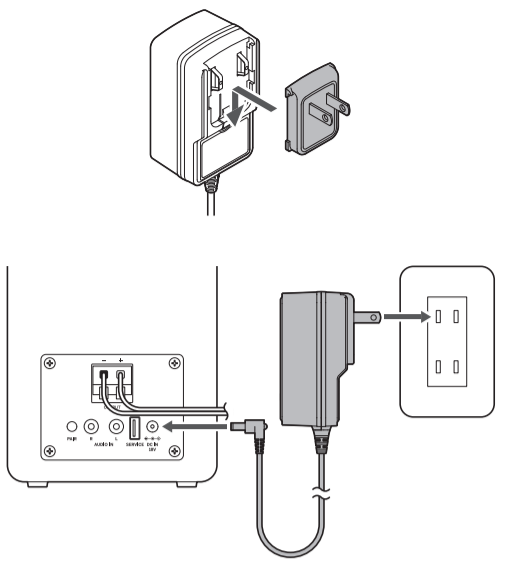

User Manual (Online Manual) https://www.audio-technica.co.jp/document/AT-SP3X/Default.html



Assistenza

Per maggiori informazioni sull'utilizzo del presente prodotto e per la risoluzione di eventuali problemi, fare riferimento al manuale dell'utente sul sito Audio-Technica.

Asistencia

Para más información sobre el uso de este producto y la resolución de problemas, consulte el manual de usuario en el sitio web de Audio-Technica.

Collegamento dei cavi degli altoparlanti / Conexión de los cables del altavoz

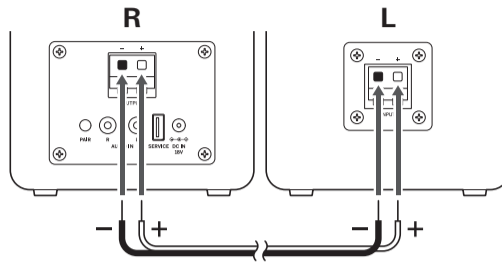

Installare la spina di ricambio per adattatore CA adatta alla presa. Instale la clavija de repuesto para adaptador de CA correspondiente a la salida.

Accensione/spengimento / Encendido y apagado

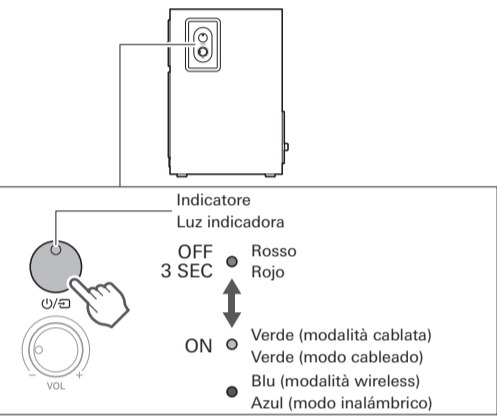

Collegamento cablato / Conexión por cable

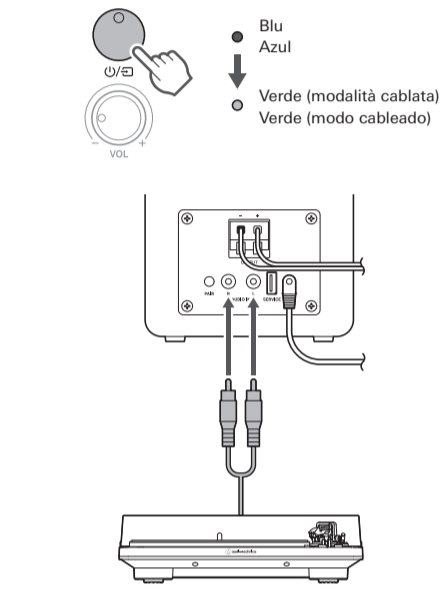

Collegamento wireless / Conexión inalámbrica

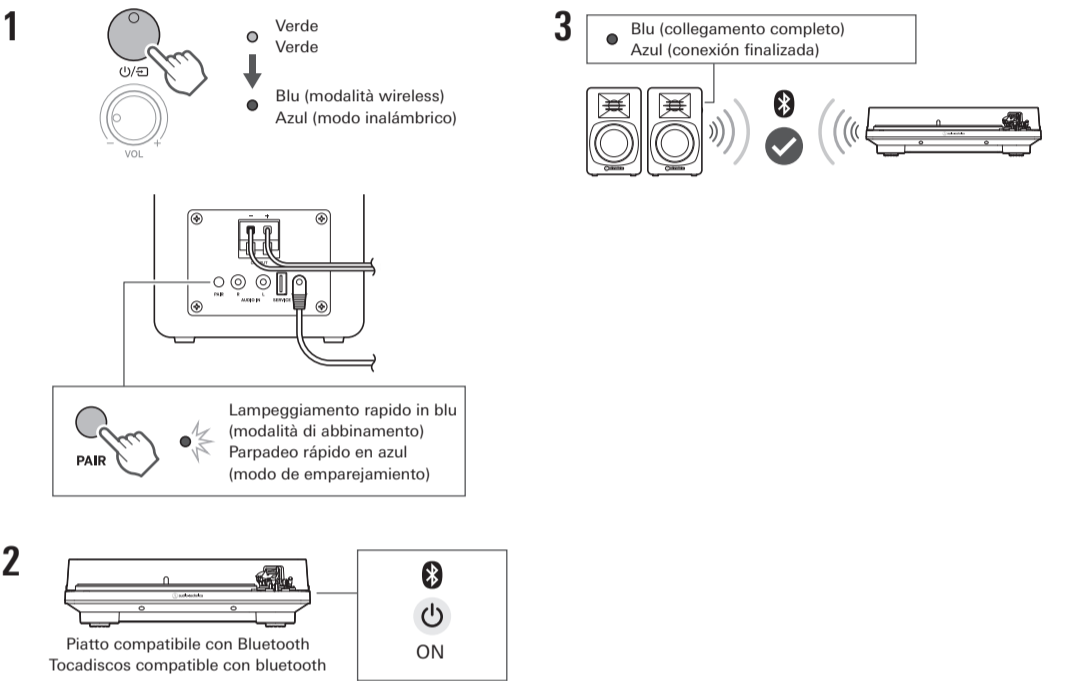

Regolazione del volume / Ajuste del volumen

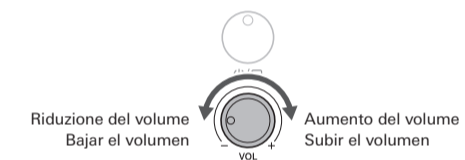

包裝內容 / 패키지 구성품

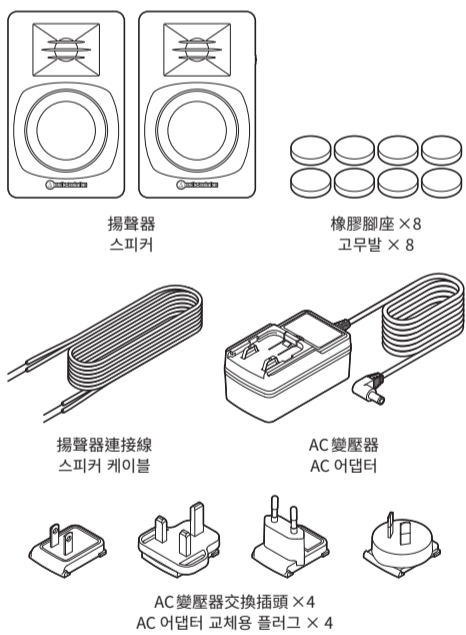

貼上橡膠腳座 / 고무발 부착

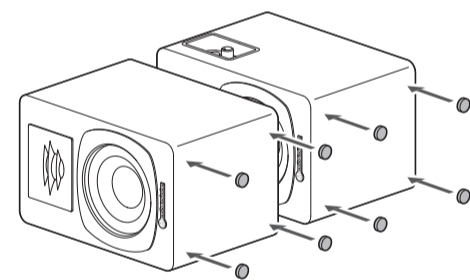

連接AC變壓器 / AC 어댑터 연결

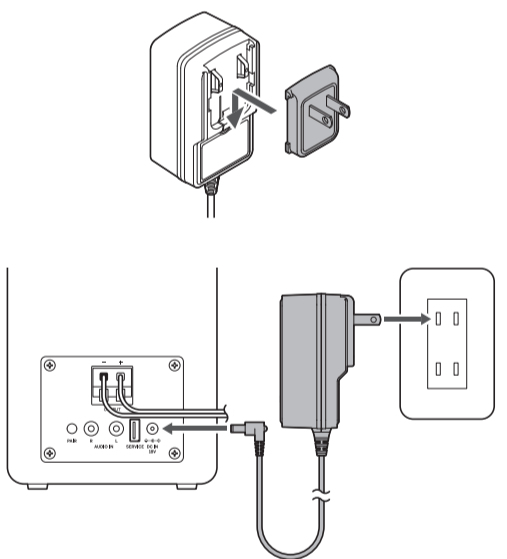

User Manual (Online Manual) https://www.audio-technica.co.jp/document/AT-SP3X/Default.html



支援資訊

有關本產品的使用方法以及各種問題的故障排除方法，請參閱「鐵三角」網站上的使用說明書。

지원

본 제품의 사용법 및 문제 해결에 관한 자세한 사항은 Audio-Technica 웹 사이트의 사용자 설명서를 참조하십시오.

連接揚聲器連接線 / 스피커 케이블 연결

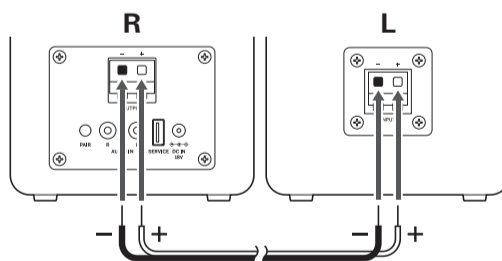

安裝與插座相符的AC變壓器交換插頭。콘센트에 맞는 AC 어댑터 교체용 플러그를 장착하십시오.

電源開啟/關閉 / 전원 ON/OFF

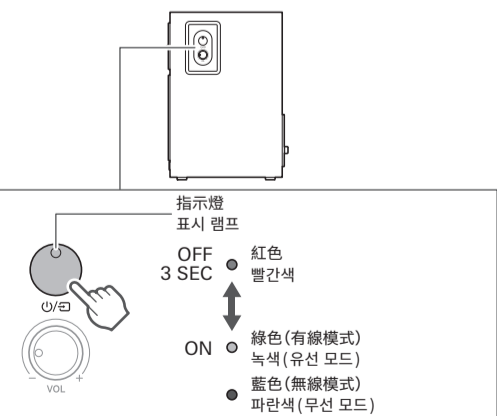

有線連接 / 유선 연결

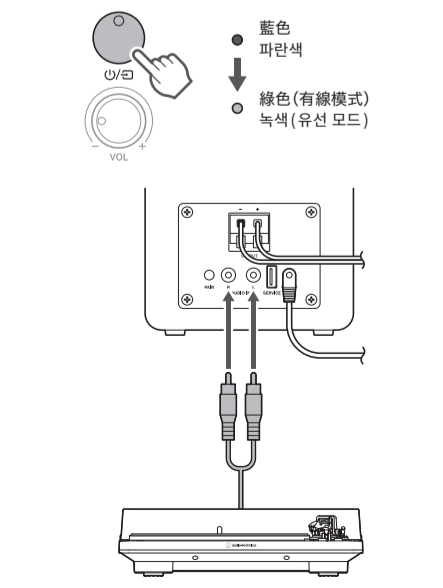

無線連接 / 무선 연결

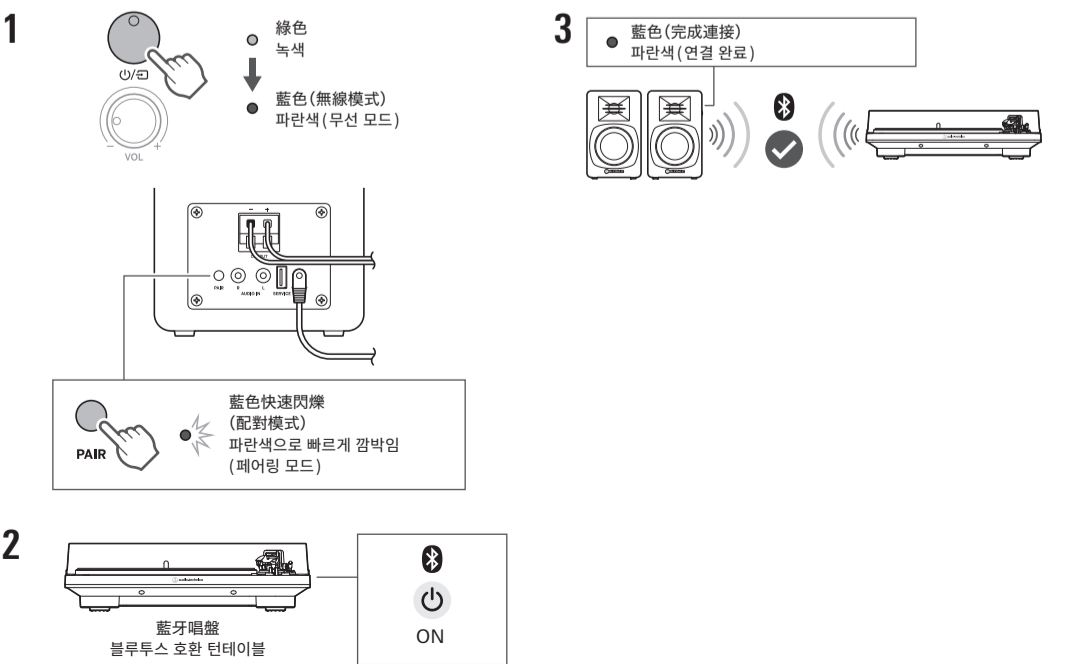

調整音量 / 볼륨 조절

